

BANCOS DE VESTUARIO

BANCOS EN ACERO

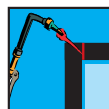

**MICRO
TEXT**



MOD. BANC-H-1500
COD. 79150

COD.	MOD.	↑	←	↗	kg	M ³
79100	BANC-H-1000	530	1000	350	12,0	0,19
79150	BANC-H-1500	530	1500	350	18,0	0,28
79200	BANC-H-2000	530	2000	350	24,0	0,37

BANCOS EN MADERA

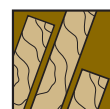
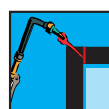

**MICRO
TEXT**



Opción repisa zapatero

MOD. BANC-1-1500
COD. 79150

COD.	MOD.	↑	←	↗	kg	M ³
79004	BANC-MINI	480	700	325	8,0	0,11
79010	BANC-1-1000	480	1000	325	9,5	0,16
79001	BANC-1-1500	480	1500	325	14,0	0,23
79020	BANC-1-2000	480	2000	325	18,0	0,31

BANCOS DE VESTUARIO

BANCOS EN MADERA

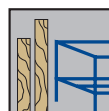

MOD. BANC-PLE
COD. 79003

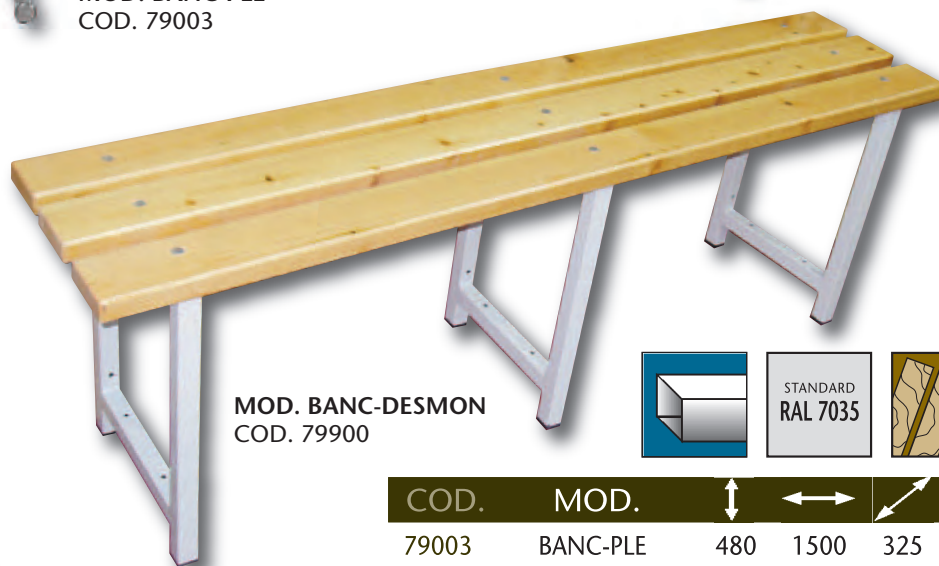

MOD. BANC-DESMON
COD. 79900

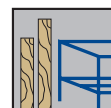

COD.	MOD.	↑	←	↗	kg	M ³
79003	BANC-PLE	480	1500	325	9,0	0,23
79900	BANC-DESMON	480	1500	325	11,1	0,23

COLGADORES



MOD. COLG-3-2000
COD. 79920



MOD. COLG-2-1500
COD. 79915



MOD. COLG-1-1000
COD. 79910

MOD. COLG-6-900
COD. 79960

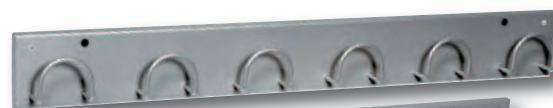

MOD. COLG-5-600
COD. 79955



MOD. COLG-4-400
COD. 79950



BANCOS DE VESTUARIO

BANCOS EN MADERA



**MICRO
TEXT**



MOD. BANC-2-1500
COD. 79013



Opción repisa zapatero

COD.	MOD.	↑	←	↗	⌋	kg	M ³
79012	BANC-2-1000	1745	1000	355	4	16,0	0,23
79013	BANC-2-1500	1745	1500	355	7	24,0	0,30
79014	BANC-2-2000	1745	2000	355	9	29,0	0,31



MOD. BANC-2-1500 DC
COD. 79213



Opción repisa zapatero

COD.	MOD.	↑	←	↗	⌋	kg	M ³
79212	BANC-2-1000 DC	1745	1000	700	8	28,0	0,46
79213	BANC-2-1500 DC	1745	1500	700	12	42,0	0,60
79214	BANC-2-2000 DC	1745	2000	700	16	52,0	0,62

BANCOS DE VESTUARIO

BANCOS EN MADERA



MOD. BANC-3-1500
COD. 79023



Opción repisa zapatero

COD.	MOD.	↑	↔	↗	↓	kg	M ³
79022	BANC-3-1000	1800	1000	355	4	21,5	0,23
79023	BANC-3-1500	1800	1500	355	7	28,5	0,30
79024	BANC-3-2000	1800	2000	355	9	33,5	0,31



MOD. BANC-3-1500 DC
COD. 79223



COD.	MOD.	↑	↔	↗	↓	kg	M ³
79222	BANC-3-1000 DC	1800	1000	700	8	37,0	0,23
79223	BANC-3-1500 DC	1800	1500	700	12	51,0	0,30
79224	BANC-3-2000 DC	1800	2000	700	16	61,0	0,31

BANCOS DE VESTUARIO



MOD. BANC-FI-1500
COD. 79006

**MICRO
TEXT**

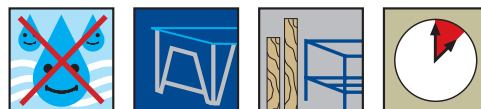

COD.	MOD.	↑	←	↗	kg	M ³
79005	BANC-FI-1000	460	1000	325	11,7	0,15
79006	BANC-FI-1500	460	1500	325	17,5	0,22
79007	BANC-FI-2000	460	2000	325	20,5	0,30



MOD. BANC-ME-1500
COD. 79009

**MICRO
TEXT**



COD.	MOD.	↑	←	↗	kg	M ³
79008	BANC-ME-1000	480	1000	325	12,0	0,19
79009	BANC-ME-1500	480	1500	325	16,5	0,29
79011	BANC-ME-2000	480	2000	325	20,5	0,38



MOD. BANC-MHD-1500
COD. 79016

**MICRO
TEXT**

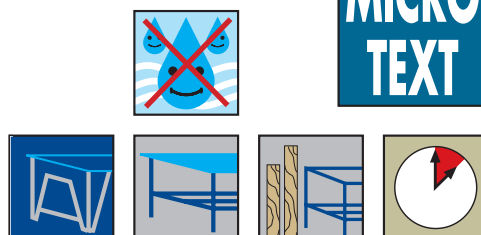

COD.	MOD.	↑	←	↗	kg	M ³
79015	BANC-MHD-1000	460	1000	325	12,0	0,15
79016	BANC-MHD-1500	460	1500	325	16,5	0,22
79017	BANC-MHD-2000	460	2000	325	20,5	0,30

BANCOS Y MESAS DE ALUMINIO

www.logirac.es
937111862

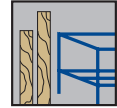
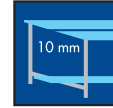

PERFIL DE ALUMINIO

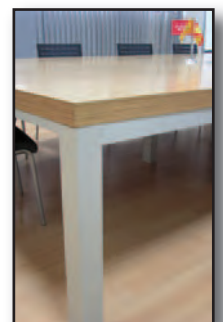
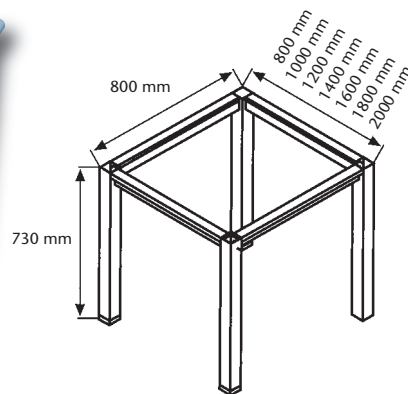
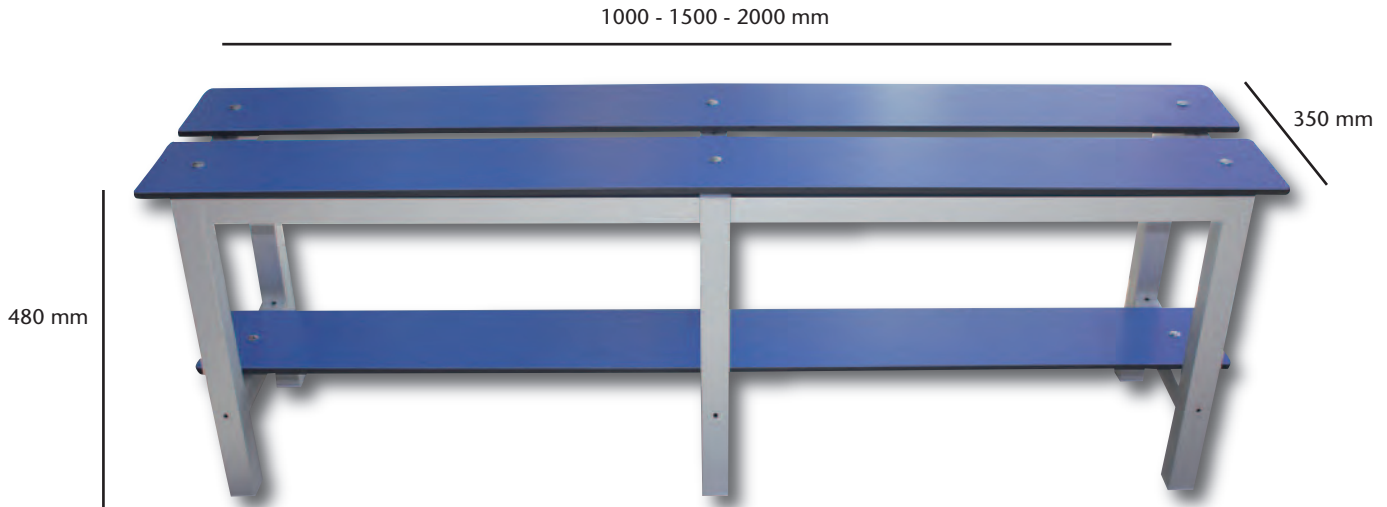

www.logirac.es
937111862